

# 1102-05 HINGE TEMPLATE

MODEL 1102, 1104, 1106 & 1108 CONCEALED  
ELECTRIC THROUGH WIRE HINGE

FOR USE WITH MCKINNEY

4.5" FULL MORTISE 3 AND 5 KNUCKLE BALL BEARING  
HINGES STANDARD WEIGHT

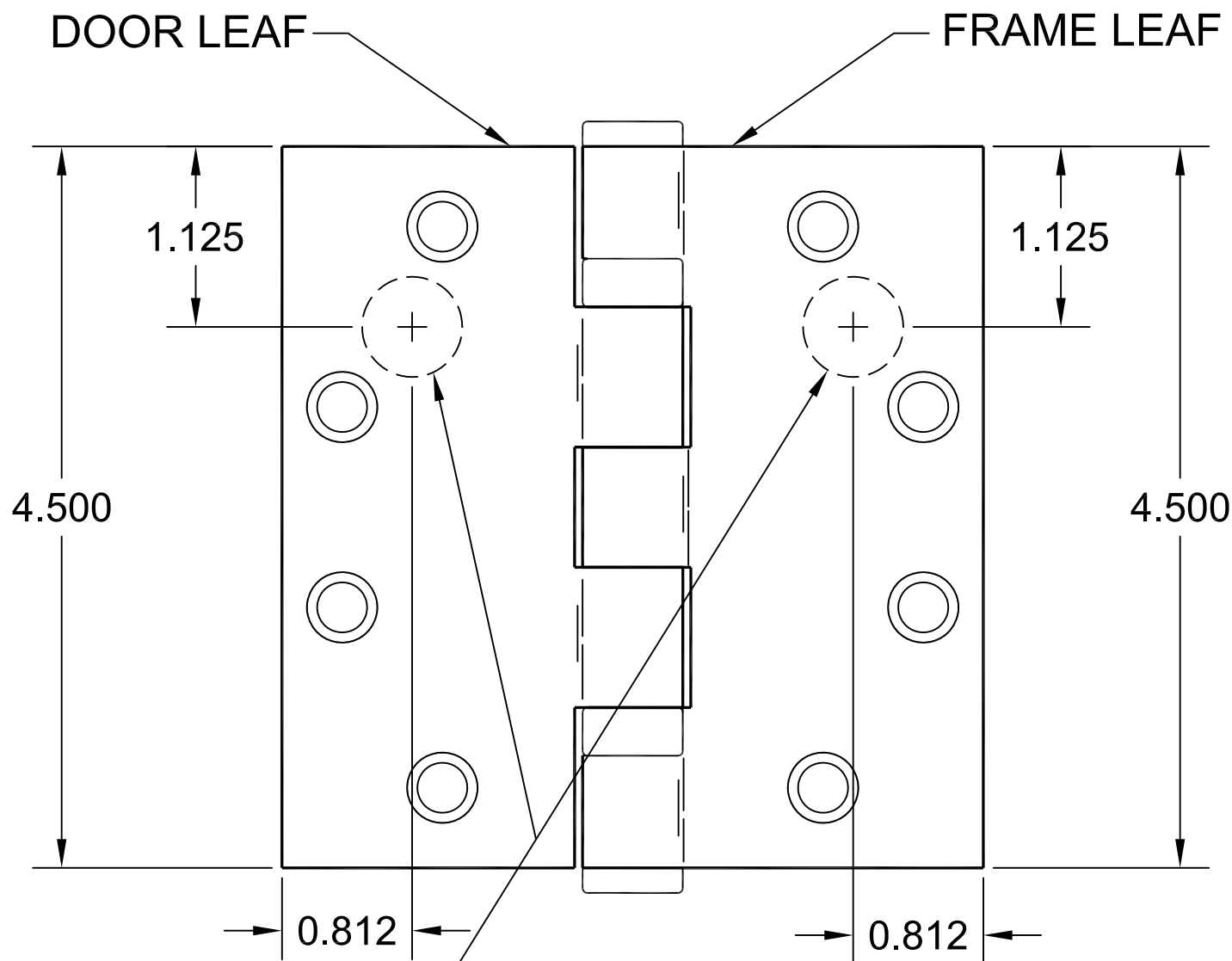

DRILL & DEBURR 5/8" DIA. HOLES  
IN DOOR AND FRAME REINFORCEMENT  
FOR WIRES.



HINGES ARE NON-LOAD BEARING  
AND MUST BE MOUNTED  
IN THE CENTER POSITION ONLY.