

1102-10 HINGE TEMPLATE

MODEL 1100-10, 1100-12, 1102X4, 1108-26 & 1100-PG
CONCEALED ELECTRIC THROUGH WIRE HINGE

FOR USE ON ALL MANUFACTURERS

5.0" FULL MORTISE 3 AND 5 KNUCKLE BALL BEARING
HINGES STANDARD AND HEAVY WEIGHT

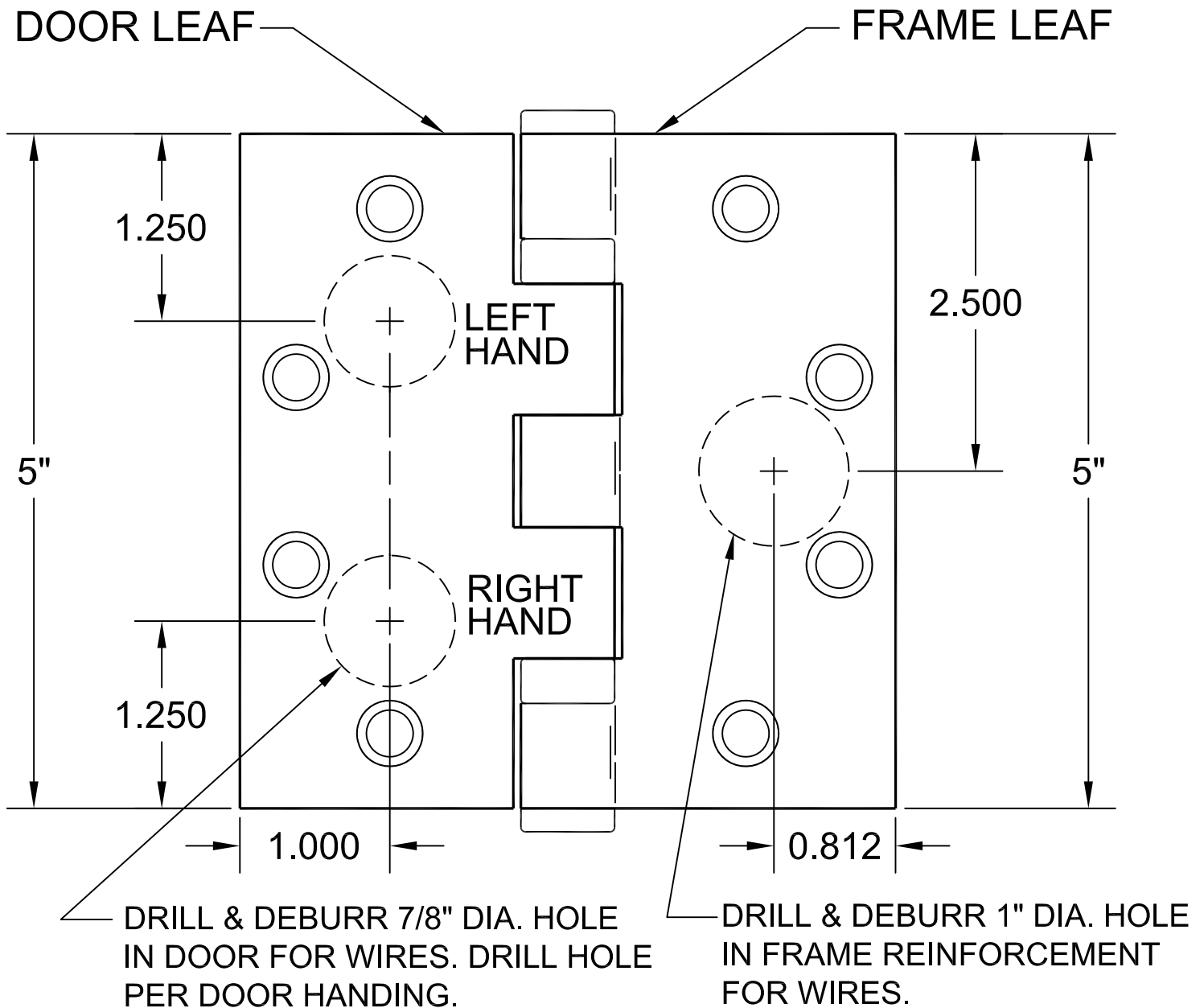

HINGES ARE NON-LOAD BEARING
AND MUST BE MOUNTED
IN THE CENTER POSITION ONLY.