

1102-17 HINGE TEMPLATE

MODEL 1102, 1104, 1106 & 1108 CONCEALED
ELECTRIC THROUGH WIRE HINGE

FOR USE WITH ALL MANUFACTURERS
5.0" FULL MORTISE 2 KNUCKLE
HINGES STANDARD AND HEAVY WEIGHT

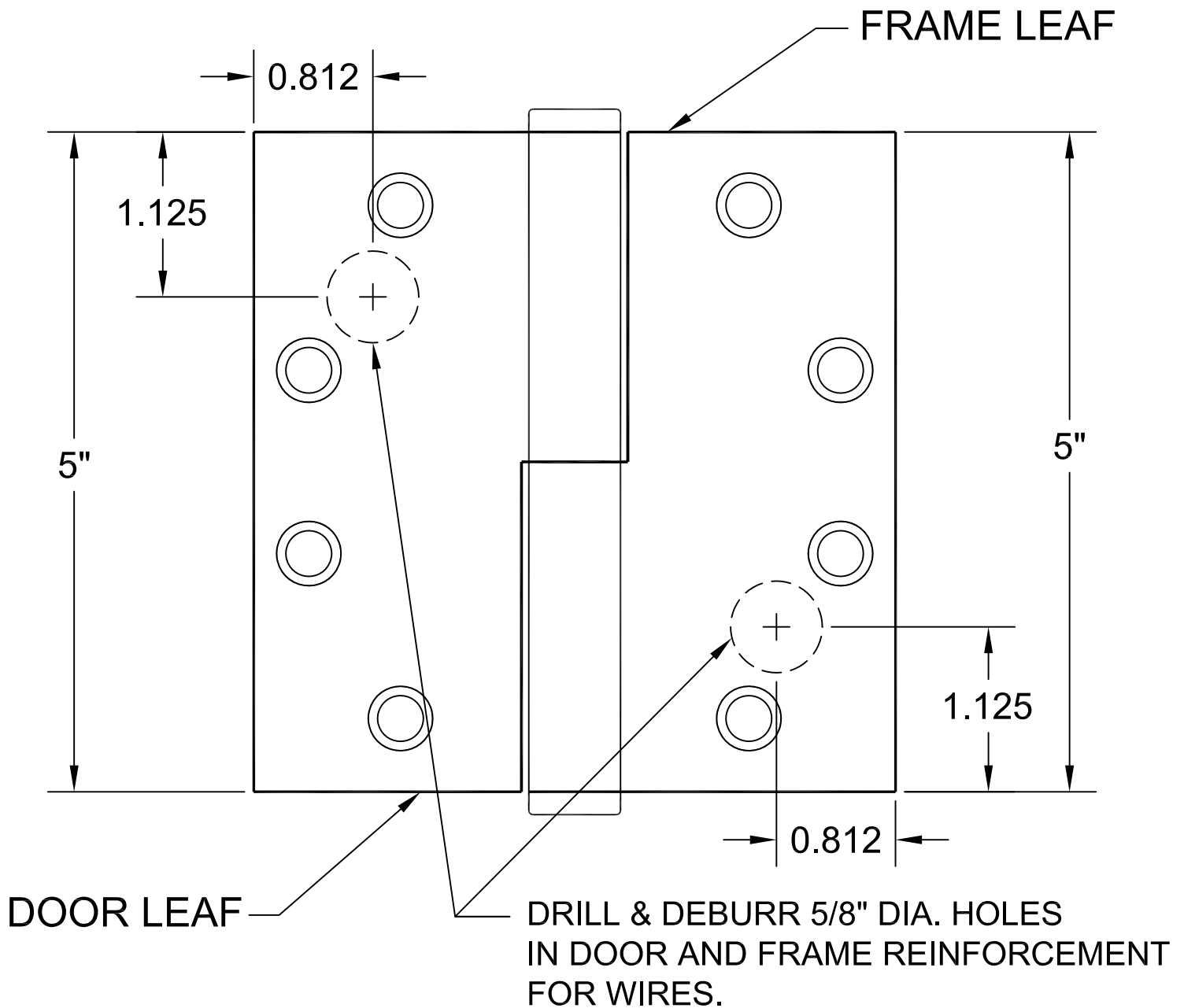

HINGES ARE NON-LOAD BEARING
AND MUST BE MOUNTED
IN THE CENTER POSITION ONLY.